

Xcab MD 22U-47U 800 mm width, 800/1000/1200 mm depth
with double door

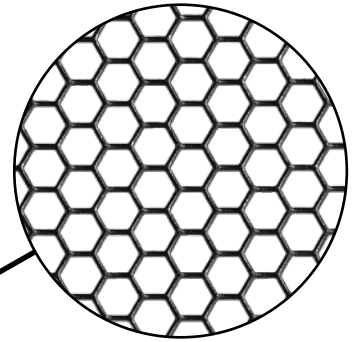

Ventilation rate 75%;

Xcab MD 22U-47U 800 mm width, 800/1000/1200 mm depth with double door

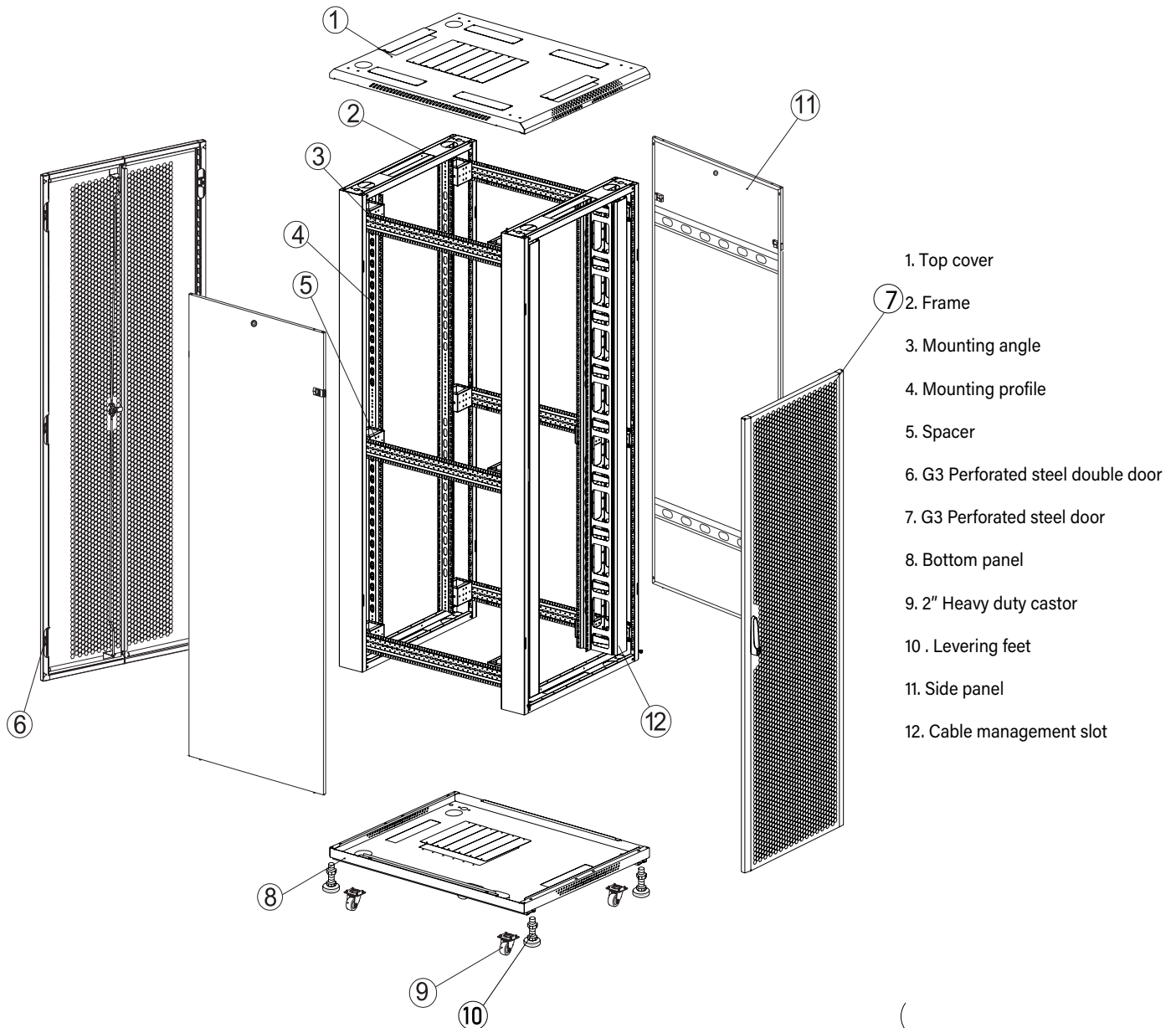

- Modular fan modules, single inventory to meet all type of cabinets to save your inventory cost.
- Coated aluminum zinc material, when the equipment is installed automatically equipotential.
- Cable entrance holes on two sides to make your wires in-and-out more convenient, and meet your requirements of strong and weak electricity cable arrangement.
- The main parts have pre-grounding stud, stud with protective cover.
- Front and rear door can be opened from left and right.
- Castors and adjustable feet can be used at the same time.
- A full range of optional accessories.

Xcab MD 22U-47U 800 mm width, 800/1000/1200 mm depth with double door

Elegant lock



Cabinet doors with cushion

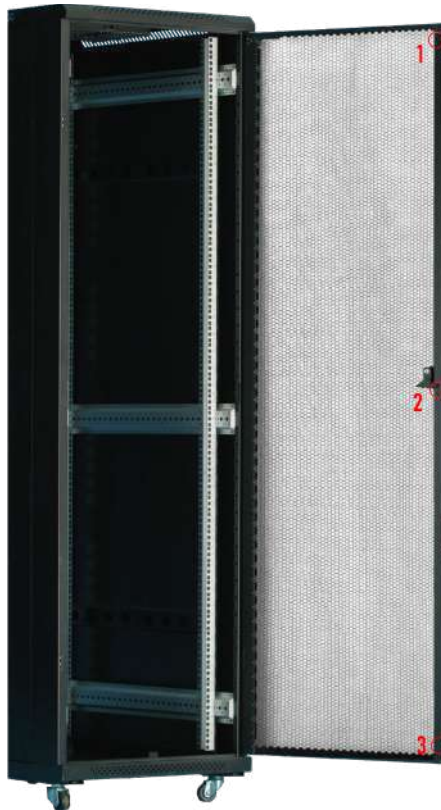

Spacer assembly



Inside view after fan module installation



Bottom cover of cabinet can be ground



M12 feet installation



Xcab MD 22U-47U 800 mm width, 800/1000/1200 mm depth with double door

The cable entry at bottom

- The cable entries are closed separately;
- Meet strong and weak wire's separated request;
- Reach 1 000pcs Cat6 cable's entry;
- Round the corner, can protect cable;

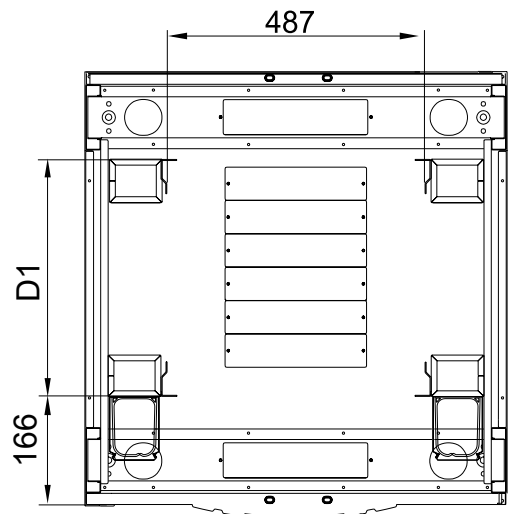
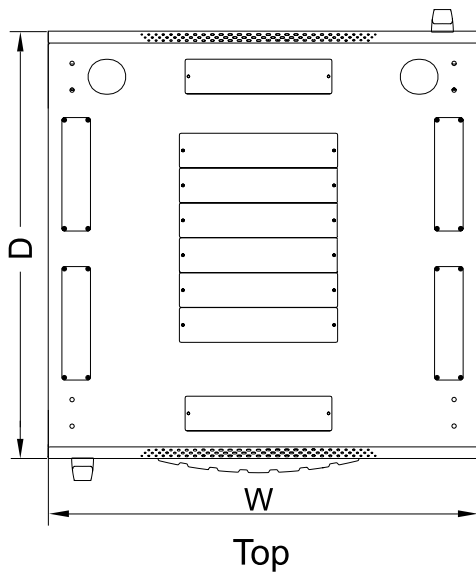

The cable entry and fan units on top:

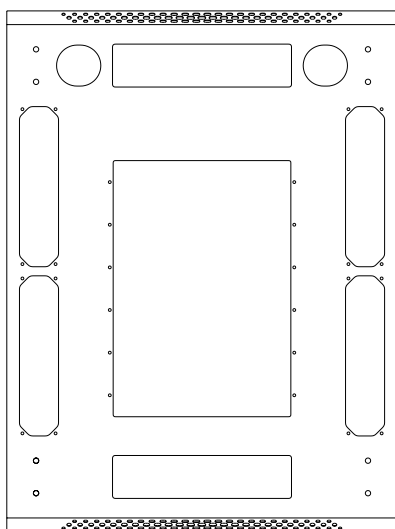

The view of the holes on top



Fan units for top cover (up to six pieces)

Xcab MD 22U-47U 800 mm width, 800/1000/1200 mm depth with double door

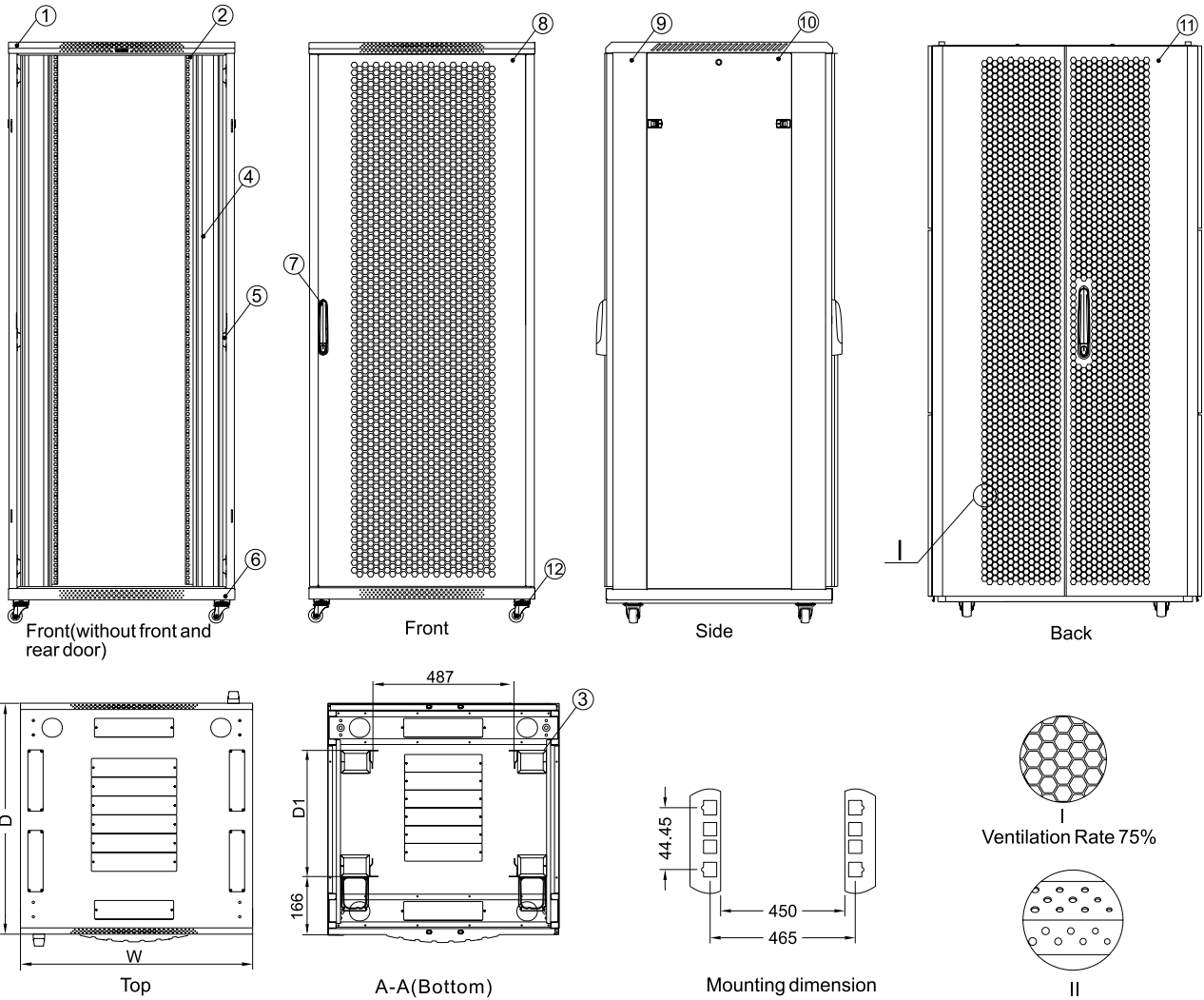

S/N	Specification	Quantity	Unit	Material	Surface Finish	Remark
1	Top cover	1	Piece	SPCC cold rolled steel t1.2	Powder coated	---
2	Mounting profile	4	Piece	Fingerprint-resistant aluminum deposited zinc plate t2.0	Material	---
3	Spacer	12	Piece	SPCC cold rolled steel t1.5	Powder coated	8pcs for lower 32U
4	Cable management slot	2	Piece	SPCC cold rolled steel t0.8/ Plastic	Powder coated	---
5	Mounting angle	6	Piece	Fingerprint-resistant aluminum deposited zinc plate t1.5	Material	4pcs for lower 32U
6	Bottom panel	1	Piece	SPCC cold rolled steel t1.2	Powder coated	---
7	Luxury lock	2	Piece	---	Black	---
8	Front door	1	Piece	5mm Toughened glass/SPCC t1.2	Powder coated	---
9	Frame	2	Piece	SPCC cold rolled steel t1.2	Powder coated	---
10	Side panel	2	Piece	SPCC cold rolled steel t1.2	Powder coated	---
11	Rear double door	1	Piece	SPCC cold rolled steel t1.2	Powder coated	---
12	2" heavy duty castor*	4	Piece	---	---	---

*Castors and adjustable feet can be used at the same time

Xcab MD 22U-47U 800 mm width, 800/1000/1200 mm depth with double door

Model No.	Capacity (U)	Width (mm)	Depth (mm)	D1 (mm)	Height (mm)	Packing Dimension	Volume (M ³)
1123434MD	22	800	800	561	1166	870*900*1196	1.9360
1123490MD			900	661		870*1000*1196	1.0405
22U80100MD			1000	736		870*1100*1196	1.1445
27U8080MD	27	800	800	561	1388	870*900*1418	1.1103
27U8090MD			900	661		870*1000*1418	1.2336
27U80100MD			1000	736		870*1100*1418	1.3570
32U8080MD	32	800	800	561	1610	870*900*1640	1.2841
32U8090MD			900	661		870*1000*1640	1.4268
32U80100MD			1000	736		870*1100*1640	1.5695
37U8080MD	37	800	800	561	1833	870*900*1863	1.4587
37U8090MD			900	661		870*1000*1863	1.6208
37U80100MD			1000	736		870*1100*1863	1.7829
37U80120MD			1200	736		870*1300*1863	2.1070
42U8080MD	42	800	800	561	2055	870*900*2085	1.6325
42U8090MD			900	661		870*1000*2085	1.8139
42U80100MD			1000	736		870*1100*2085	1.9953
42U80110MD			1100	736		870*1200*2085	2.1767
42U80120MD			1200	736		870*1300*2085	2.3581
47U8080MD	47	800	800	561	2277	870*900*2307	1.8044
47U8090MD			900	661		870*1000*2307	2.0070
47U80100MD			1000	736		870*1100*2307	2.2078
47U80110MD			1100	736		870*1200*2307	2.4085
47U80120MD			1200	736		870*1300*2307	2.6092

Surface finish:

•Degreasing, Vitrification, Power coated;

Degree of protection:

•IP20.

Loading capacity:

•Static loading: 800KG (with ajustable feet)